

Name: Gas Volume Conversion Device (EVC)
Type: MacBAT 5

Installation manual

Document issue: 1.2 / 06-2023

Applies to the following firmware:

Program series: S012.xx



Implicitly read the user manual, which contain all necessary information about appliance, including safety information. This is only a supporting document, which includes only selected information, useful during device installation. Installation manual is only an annex to the main document.

User manual along with information regarding safety and a template of EU conformity declaration is available on website <https://gas.plummac.com/en/> after logging into your Client Panel (link in QR code) under MacBAT 5 section.

QR code link:



SAFETY



MacBAT 5 EVC is an 'ia' intrinsically safe, explosion proof device and can be installed in 0,1 or 2 explosion zone of gases and vapors which are placed in IIB or IIA explosive group and temperature class T1, T2, T3, T4.

Ex mark  II 1G Ex ia IIB T4 Ga. Device installation in explosion hazard areas must comply with requirements of applicable regulations.



Minimum requirements for improving the safety and health protection of workers potentially at risk from explosive atmospheres are prescribed in Directive 1999/92/EC of the European Parliament and of the Council of 16 December 1999 (ATEX 137 'Worker Protection Directive').



Internal intrinsically safe circuits, including pressure and temperature sensors internal circuits, do not stand 500V test given in EN60079-11 to earthed or isolated metal parts of its enclosure. The type of protection does not depend on the separation. Metal bushings of product and metal parts of its pressure sensors are galvanically connected. It can be installed as fully floating or bonded. It must be considered during installation.



The person installing the device is responsible for checking the continuity of protective connections.



The manufacturer's declaration of the IP66 housing tightness class will be valid only if cables with appropriate diameters for the cable bushings are used, the bushings are properly tightened, and ensuring proper placement of gasket and tightening of the housing cover to the device casing.



Under certain extreme circumstances, the plastic enclosure or plastic parts of the enclosure may store an ignition-capable level of electrostatic charge. The product should not be installed in a location where the external conditions are conducive to the build-up of electrostatic charge. The product shall only be cleaned with a damp cloth.



The function and parameters of some inputs/outputs depend on the product version, details are given in user manual of the device.

POWERING FROM BATTERY

The device is powered with lithium-thionyl batteries with nominal voltage of +3,6V, size D, in compliance with IEC 60086-1. Any works with the battery can be done only by trained personnel.



It is allowed to use only battery types provided below:

- LS 33600, manufactured by Saft Specialty Battery Group
- EVE ER34615, manufactured by Eve Energy CO., LTD.
- (using this battery environmental temperature should be in range of: Ta= -25°C..+50°C)
- SL-2780, manufactured by Tadiran Batteries GmbH



There is also a backup battery concealed under the main board cover. Allowed types of backup batteries SAFT LS14250 or FANSOER14250H.



Caution. Risk of explosion if the battery is replaced by an incorrect type. Dispose of used batteries in accordance with the user manual of the device.

PREPARATION FOR WORK

For transport purposes, all batteries (main B1 (EVC), modem B2 B3 and backup battery - hidden under the cover) have been disconnected in the unit using insulating dividers).

 **Before assembling the unit, remove all fitted divider (marked with an arrow and the word PULL).**

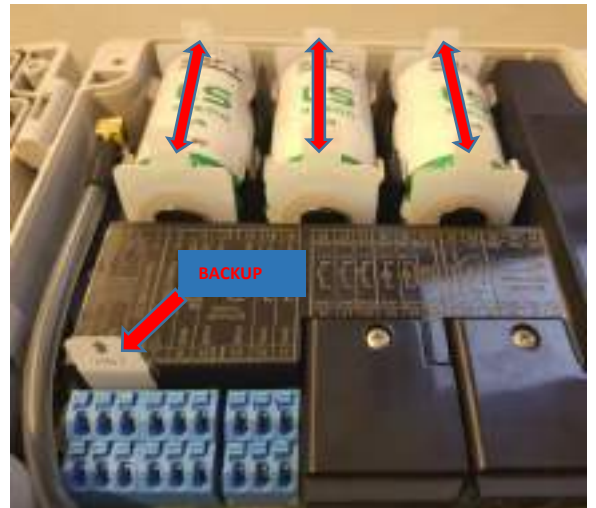

SIM CARD AND MOBILE ANTENNA INSTALLATION



If the converter is equipped with internal modem a SIM card of miniSIM size must be placed inside, under the battery marked as B3. In place of one cable gland there is FME antenna socket to connect external mobile antenna. The antenna with the magnetic base should be fixed to a metal element nearby, such as the wall of a container.

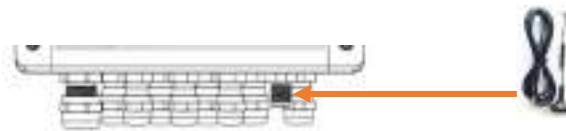

MECHANICAL INSTALLATION AND CONNECTION

First of all, the converter must be firmly attached to a solid element, considering provided external dimensions. For gas pipeline installation a dedicated mount bracket can be used to install the converter.

For installation the following tools are necessary:

- Fork spanners 14, 17, 18, 22



- Philips screwdriver min. 100mm long



- Adjustable spanner, spacing 28



- Allen key no.4 and 5, min. 100mm long



- Ferrule crimper



Depending on the type of device, internal pressure sensors can be connected to the gauge point with pulse tube or if converter is equipped with external pressure sensors, they can be connect directly to the gauge point.



It is recommended to install device's pressure sensors behind the three-way or two-way valve, which cuts off gas flow to the converter.



Temperature sensor should be placed in thermowell of gas pipeline. It must not be in direct contact with the gas to be measured.

- **Mounting on a flange bracket:**

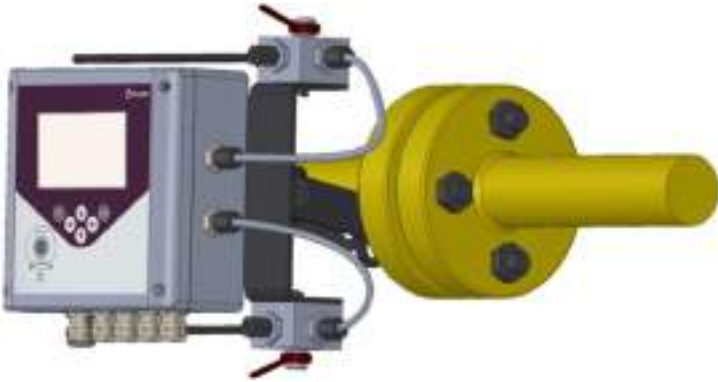

The bracket should be screwed under the one bolt that ties the pipe flanges together. Then, using the supplied M5x40 screws, tighten the device to the bracket. The mounting holes are accessible after opening the unit casing. Use the two holes on the right-hand side.

If the unit is equipped with an internal pressure sensor, the three-way valve should be placed on the bottom or top of the holder and fixed using the prepared threaded holes.

Using a 6mm pulse tube, connect the output of the three-way valve to the pressure point.

The correct assembly is illustrated in the drawing.

- **Mounting with tube holder and hose clamp:**

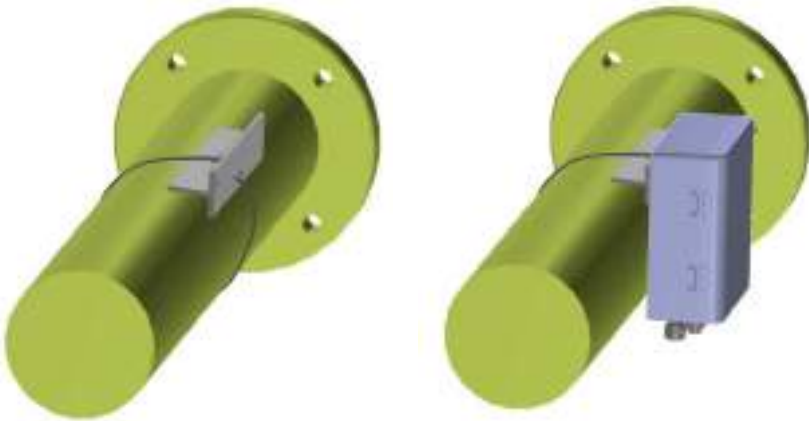

Select a suitable mounting location for the holder on the horizontal gas pipeline. Use a hose clamp to fix the holder to the gas pipe. Twist the clamp with a Phillips screwdriver to prevent the holder from moving on the pipe.

Open the device enclosure and screw the device onto the holder using the two upper holes.

- **Common information to the two types of assembly**



If the device is equipped with an external pressure sensor with the cable, it is not necessary to screw the three-way valve to the bracket itself. It is possible to locate the valve directly at the pressure gauge point, and sensor can be connected to the valve. There is no need for pulse tubes.

The correct assembly is illustrated in the drawing.

PREPARATION OF PULSE TUBES AND CUTTING RINGS

Pipe preparation.

1. Use 6 mm diameter stainless steel tube
2. Cut the tube at a right angle. A deviation of 0.5° from the right angle is permissible.
3. Remove internal and external irregularities.
4. Observe minimum lengths $H \geq 25\text{mm}$, $L \geq 32\text{mm}$.



Installation with fork spanner (for single- and double-edge cutting rings).

1. Slide the cutting ring and sealing nut onto the pipe as shown below.
2. Insert the pipe into the socket of pressure sensor and tighten sealing nut by hand as far as it will go.
3. While pressing the pipe into the socket in the pressure sensor, tighten sealing nut with a spanner by $1/2$ turn.
4. **Jam check:** unscrew sealing nut and check that the collar covering the front part of the jamming edge has appeared. The cutting ring is allowed to rotate, but the ring must not move along the pipe.
5. **Reassembly:** if the cutting ring jam is correct, tighten the sealing nut with the same force as during assembly. To achieve this, tighten the sealing nut by hand as far as it will go, then using a spanner tighten it another $1/2$ turn.

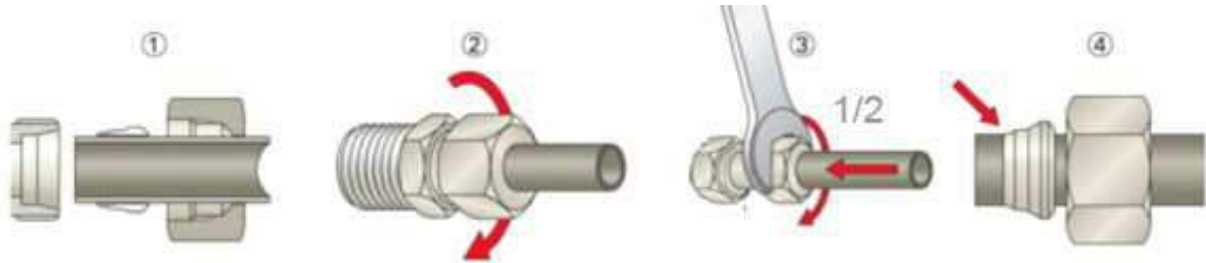

The pressure transducer inside the enclosure is protected from rotation by a 5mm thick steel plate, which has a hole shaped to suit the key grip on the port of this transducer. Due to the fit, minimal movement of the sensor (up to 5°) during screwing / unscrewing of the pulse tube is allowed.

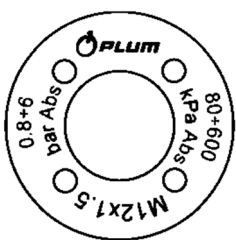
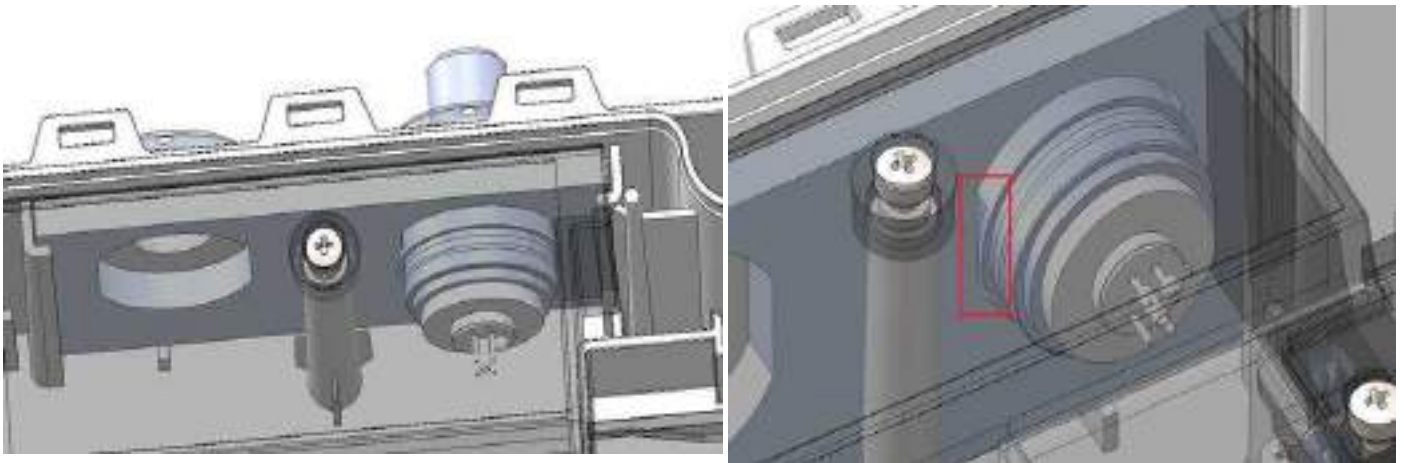

(front view)



The ring securing the pressure transmitter from the outside of the enclosure, only serves to mount the transmitter in the device enclosure, and at the same time to ensure the tightness class by tightening the gasket placed between the enclosure and the ring.

Do not use the transducer mounting ring to counteract the pulse tube mounting nut. The way in which the transducer is mounted in the device enclosure ensures that there is no need for counteracting.

PREPARATION OF CABLES

Due to glands and splice connectors diameter multi-cored cables with cross section from 0,25mm² to 0,75mm² should be used. The cables should be terminated according to the manual below.

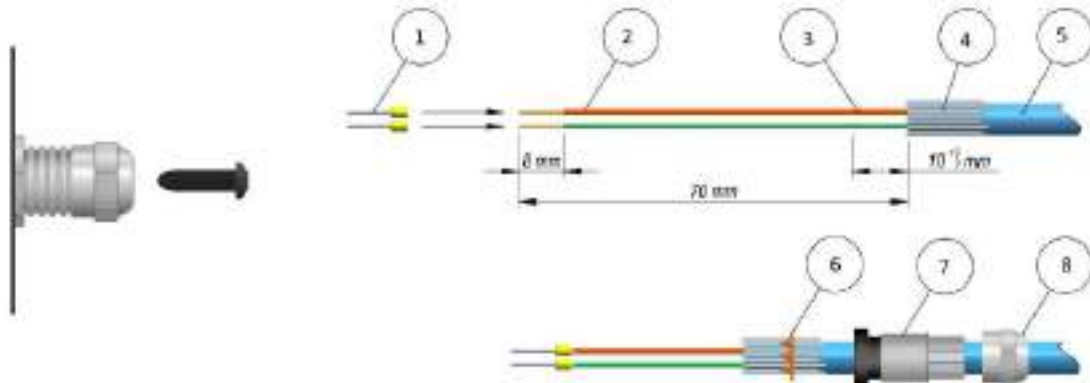

1 – ferrules, 2 – wires, 3 – foil, 4 – shield, 5 – cable, 6 – shaped gland ring, 7 – seal, 8 – gland nut.

Remove the bolt placed in gland. Prepare the cable in accordance with above illustration. After placing the ferrule crimp it with ferrule crimper. Insert shaped gland ring from point 6 onto rolled up cable shield (onto insulation) – to half of the length.

To connect the measuring cables they must be inserted into terminals chamber through correct cable glands. The cable glands are adjusted to earthing of cable shields.

M12x1.5 cable glands - cable outer diameter range: 3-6.5 mm²

M16x1.5 cable glands - cable outer diameter range: 4-8 mm²

⚠ Cables and wires of intrinsically safe circuits must be placed separately to cables and wires of non-intrinsically safe circuits. Cables and wires of intrinsically safe circuits should be installed permanently and secured against mechanical damage.

CT6 temperature sensor, EPS pressure sensor:

Cables: factory-made. Maximum length 10 m.

DI digital inputs (LF, HF, digital inputs, NAMUR digital inputs):

Cables: LIYCY 2 x 0,25 - 0,5 mm² or LIYCY 4 x 0,25 - 0,5 mm². Maximum length 10 m.

COM1 and COM2 ports, converter and internal modem powering (POWER SUPPLY), DO outputs.

Cables:

- LIYCY 2..10 x 0,50 mm² – max 150 m
- LIYCY 6..10 x 0,75 mm² – max 200 m

or paired cables:

- LIYCY-P 2..5 x 2 x 0,34 mm² – max 100 m
- LIYCY-P 2..5 x 2 x 0,50 mm² – max 150 m
- LIYCY-P 2..5 x 2 x 0,75 mm² – max 200 m.

Number of wires required to connect:

- 2 wires to power the converter and internal modem – on-line operation mode
- 4 wires to power the converter and transmission on one RS485 channel
- 6 wires to power the converter and transmission on two RS485 channels
- 7-10 wires to power the converter, transmission, DO digital outputs

⚠ Tighten the nuts of all glands during installation to achieve declared IP protection level. Producer does not provide the devices with cable gland tightened.



CABLES AND EXTERNAL CIRCUITS CONNECTION

Available converter terminals identification:

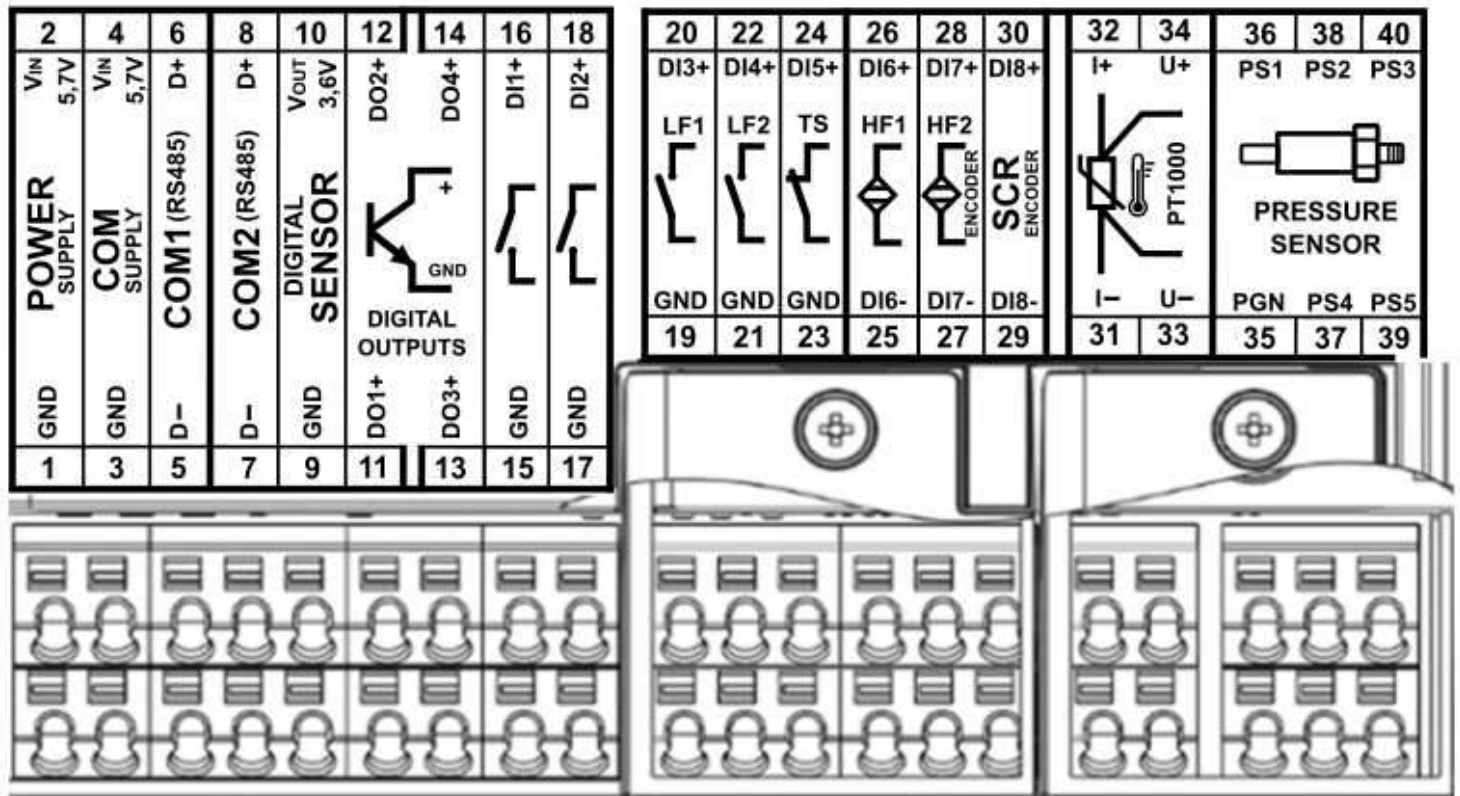

- 1-2 – external power supply terminals (POWER SUPPLY) (main power supply)
- 3-4 – external power supply of transmission circuits terminals (COM SUPPLY) (only if POWER SUPPLY is not used)
- 5-6 – RS485Ex serial transmission ports terminals (COM1)
- 7-8 – RS485Ex serial transmission ports terminals (COM2) or Modbus MASTER communication with external devices of 3rd party producers (e.g. pressure transducers)
- 9-10 – power supply terminals for external devices of 3rd party producers (e.g. pressure transducers) (DIGITAL SENSOR)
- 11-14 – DO digital outputs terminals OC type (DIGITAL OUTPUTS DO1...DO4)
- 15-18 – digital input terminals (bistate signalization) (DIGITAL INPUTS DI1...DI2)
- 19-22 – digital input terminals (bistate signalization) shared with LF1 and LF2 pulse inputs (DI3...DI4)
- 23-24 – digital input terminals (bistate signalization) shared with TS control contact (DI5)
- 25-26 – digital input terminals (NAMUR signalization) shared with HF1 pulse input (DI6)
- 27-28 – digital input terminals (NAMUR signalization) shared with HF2 pulse input and NAMUR encoder (DI7)
- 29-30 – SCR Encoder input terminals (SCR ENCODER) or digital input terminals (bistate signalization) (DI8) (depends on description on the main board cover)
- 31-34 – basic CT6 temperature sensor terminals (PT1000, I+, I-, U+, U-)
- 35-40 – EPS external pressure sensor terminals (PRESSURE SENSOR, PS1...PS5, PGN)

To connect external circuits self-locking terminals are used. Stripped wires must be obligatorily terminated with 8mm long ferrule. After placing wire in the terminal it will be locked automatically in it. By pulling lightly, check that it has been tightened in the terminal.

 **A terminal cover (marked in red in the photo, covering terminals 1÷12) should be used on a unit with a metal enclosure. The wires should be arranged in such a way that they do not come close to the tape connecting the base to the cover. The wires inside the unit should not come into contact with the enclosure.**

 **After connecting the wires to the terminals, it is recommended to tighten the upper enclosure cover with four screws to a torque of 0.8 Nm.**



CONNECTING INT-S3 INTERFACE AND EXTERNAL CIRCUITS

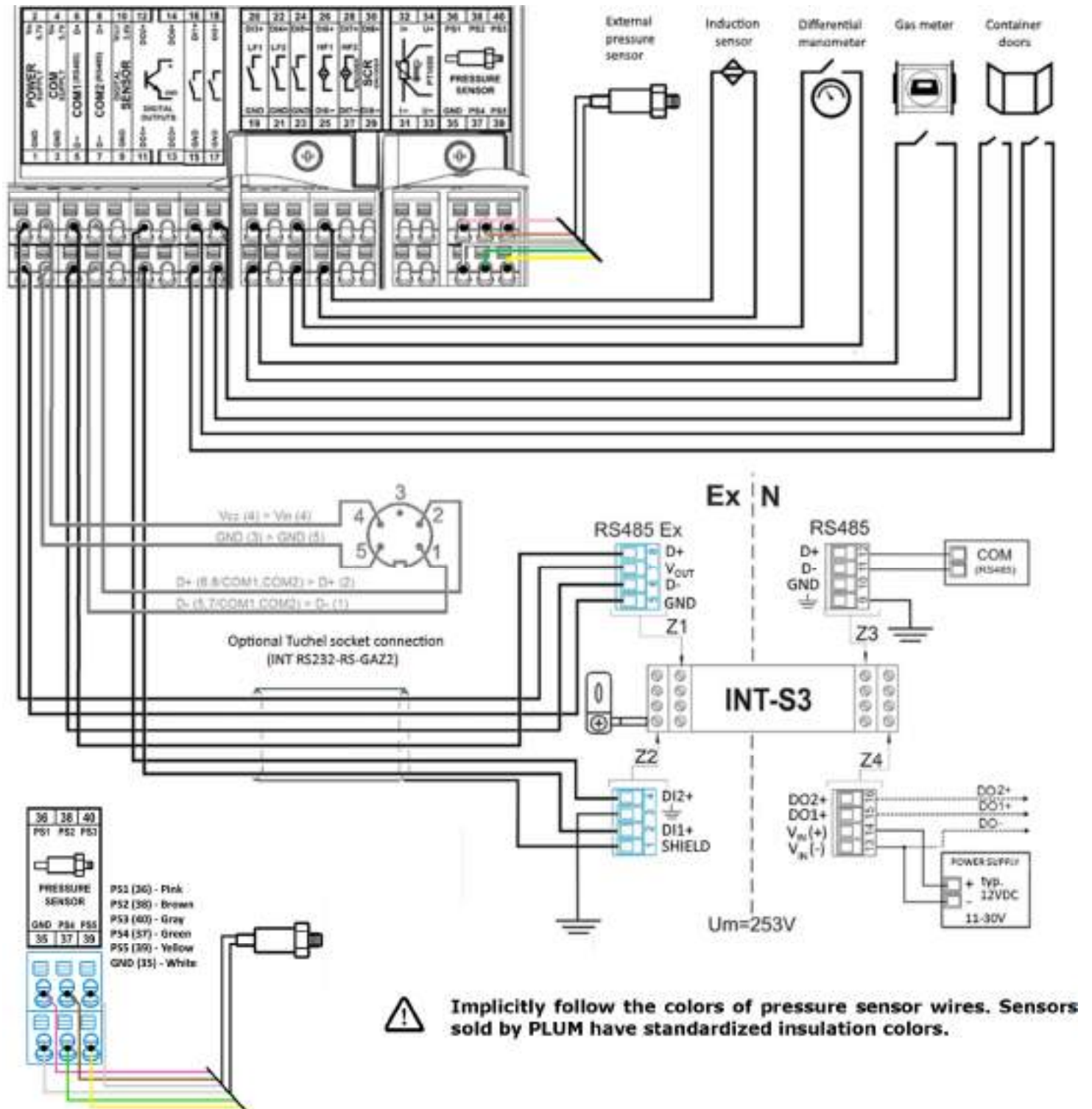

RS485Ex port in INT-S3 can be connected with COM1 or COM2 in MacBAT 5.

To provide transmission on second COM port and to power two additional digital outputs, a second INT-S3 or INT-S3/N interface should be used – without using V_{OUT} (7) and GND (5) terminals.

- ⚠ **Do not use INT-S3/N to power MacBAT5.**
- ⚠ **Do not use one INT-S3 interface to power supply two converters at the same time.**
- ⚠ **Do not connect INT-S3 interface to COM SUPPLY terminals.**

HANDLING THE CONVERTER AND CONFIGURATION USING KEYBOARD

The keyboard has 6 buttons: **enter** for entering the menu, accepting choices; **esc** for returning to parent menu or abandoning selected function; arrows ←→↑↓ are navigation buttons through the menu. After selecting any parameter and pressing → arrow „to the right” a short description shall appear. Converter’s main screen contains basic information on currently logged parameters.

Changing individual configuration parameters requires user authorization, which can be provided in two ways:

- Selecting appropriate user account (e.g. Account **Adm401** – Administrator, account 401) and entering password (**4096** by default with option to change it).
- Switching programming blockade inside the device housing, marked as CFG, to position of an open padlock disables user authorization request and allows full access to the device. This way is recommended during first configuration. After setting access passwords the converter should be set to locked padlock position, next it is suggested to seal it in order to avoid unauthorized access to the device.

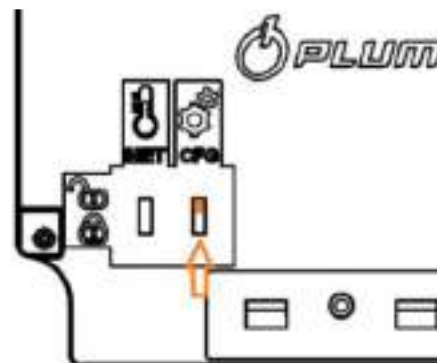

All settings described below start from the main menu (first after device start-up).

Configuration after device installation	
Menu language <i>enter -> Configuration -> Language</i> <i>enter -> Konfiguracja -> Język</i> <i>enter -> 2x 'up arrow' -> enter -> enter</i>	<ul style="list-style-type: none"> • menu language (ConfLang) – EN - English
Date and time <i>enter -> Configuration -> Date and time</i> <i>enter -> Configuration -> Date and time -> Advanced</i>	<ul style="list-style-type: none"> • date and time (DT) • clock operating mode - automatic time adjustment summer/winter (AutoDST)
Data registration <i>enter->Data->Configuration->Basic</i>	<ul style="list-style-type: none"> • registration period (Dtau) • hour to start billing day (Billing Hour)
Power supply of device <i>enter->Configuration->Power source->External</i>	<ul style="list-style-type: none"> • power source operating mode (EpwrSMode) (FULL – external powering, BATT – battery powering)
Flow meter (gas meter) settings <i>enter -> Measuring inputs -> Gas meter</i> <i>enter -> Measuring inputs -> Flowmeter -> Pulse factor</i> <i>enter -> Measuring inputs -> Flowmeter -> Counters</i> <i>enter -> Measuring inputs -> Flowmeter -> Measuring range</i> <i>enter -> Measuring inputs -> Flowmeter -> Limits</i>	<ul style="list-style-type: none"> • configuration of type of connection with gas meter (ConfImp) (e.g. LF1/HF1 – connection via pulse transmitters LF and HF from gas meter) • gas meter pulse factor (e.g. LF1Factor) (imp/m³ unit) • Volume at measuring conditions (Vm) -gas meter counter • gas meter range (QmRMin / QmRMax) • limits of flow (np. QmLMin)
Algorithm and gas composition <i>enter -> Gas and conversion -> Algorithm</i> <i>enter -> Gas and conversion -> Gas composition</i>	<ul style="list-style-type: none"> • selecting algorithm to determine gas compressibility factor, e.g. SGERG-88 (ConfAlgZ) • selecting the origin of components of simplified gas composition (Full.comp.–from full gas composition, Simpl.–from simplified gas composition) • Full or Simplified gas composition
DI Digital inputs (signalizations) <i>enter -> Inputs / outputs -> Digital inputs -> Configuration</i>	<ul style="list-style-type: none"> • Selection of available inputs (possibility of using them) (ConfDI) (0-input unavailable, 1-input available) • Inputs polarization (DIPol) (0-normally closed, 1-normally opened)
DO Digital outputs (OC type) <i>enter -> Inputs / outputs -> Digital outputs -> e.g. DO1</i>	<ul style="list-style-type: none"> • Output operating mode DO (e.g. DO1Mode) (e.g. Status (S) – controlling by event-status-active closed (shorted) e.g. Events (S) – controlling by event-pulse-active closed (shorted)) • Code of event controlling output DO (e.g. DO1Evt) (e.g. 52-Collective alarm A)
Data transmission (COM ports) <i>enter -> Configuration -> Transmission -> e.g. COM1</i>	<ul style="list-style-type: none"> • COM port baud rate (e.g. COM1Bps) • COM port address (e.g. COM1Adr)
Data transmission (internal modem) <i>enter->Configuration->Transmission->Modem->Configuration</i>	<ul style="list-style-type: none"> • pin to SIM card (MPin) • APN #1 of SIM card (MApn1) • Modem operating mode (MMode) (e.g. OnLine - Online mode with external power supply) • Port number to operate in <i>Online mode with external power supply</i> (MPort)
Passwords <i>enter -> Configuration -> Advanced -> User passwords</i>	<ul style="list-style-type: none"> • Administrator password – 401 account (Adm401Pwd) • User password – 301 account (Cust301Pwd) • User password to read data – 201 account (Rdr201Pwd)

CONVERTER CONFIGURATION USING SMARTPHONE

To configure MacBAT 5 using smartphone use „**ConfIT! volume converters**” application available free of charge via Google Play (next is a QR link to the application). Application enables connecting the device via Bluetooth (and OptoBTE_x interface) or via NFC in smartphone. It requires that smartphone had Android 5.0 or higher installed.



Link to ConfIT! volume converters:



1. Start the application on smartphone, select „NFC” connection option and apply smartphone (with its NFC antenna) to MacBAT5 device, to a place marked as “NFC”. ATTENTION – each smartphone have NFC antenna installed in a different place – please check it in smartphone’s manual.

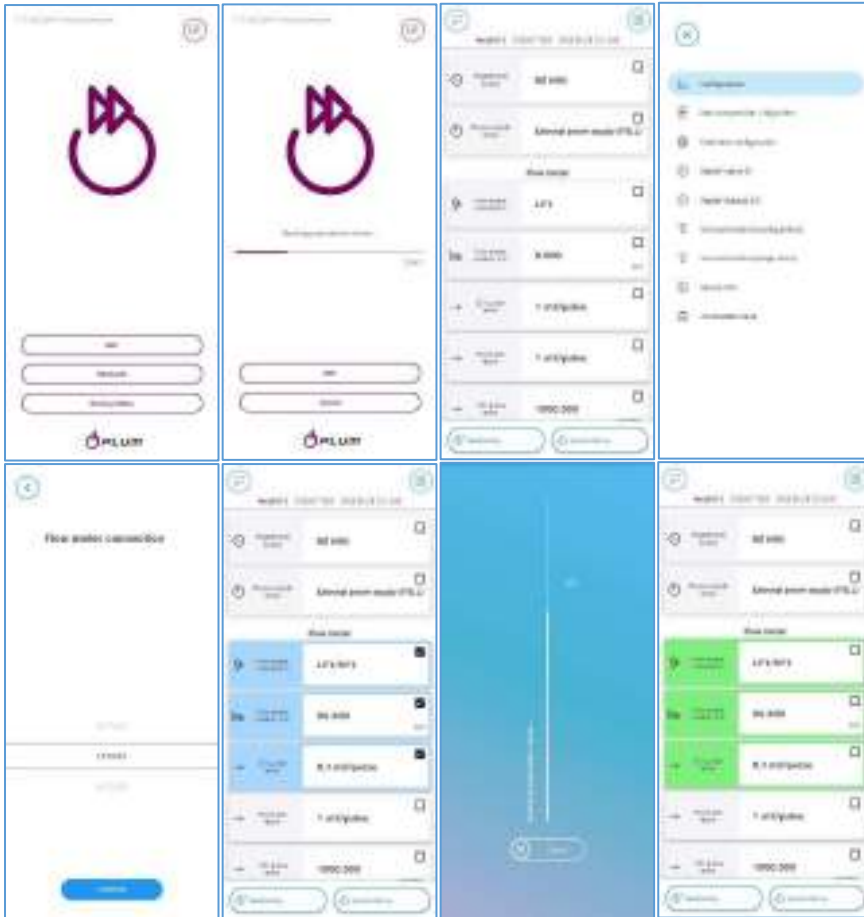

2. Correctly established connection will effect in displaying reading bar and finally reading converter configuration parameters from the device.

3. Take smartphone away from the device.

4. Application uses **401** account (Administrator) and **4096** password by default, to authorize modification of configuration. These data can be changed in right application menu, in ‘User account’ option.

5. Enter new configuration parameters values into individual settings categories (left application menu).

6. Select „Save to device” button and once again apply smartphone to MacBAT 5.

7. New configuration will be saved in the device, the “Transmission successful” notification shall confirm it.

8. Select „Read device” option and make sure that after another configuration reading all programmed parameters are set in the device.

For configurations using Bluetooth and the OptoBTE_x interface:

- start the OptoBTE_x interface
- place it on the MacBAT 5 at the OPTICAL INTERFACE so that the blue LED is on the right side
- switch on the device display
- launch the application on your smartphone and select the “Bluetooth” connection option.
- configure the device in the same way as with the NFC connection.

In the case of a Bluetooth connection, it is automatically maintained by the app, so there is no need to remove the interface from the device.



CONVERTER CONFIGURATION USING COMPUTER

To configure MacBAT 5 using computer use ConFIT! application available free of charge on website <https://gas.plummac.com/en/> (direct link in QR code). Application enables connecting the device via serial port (e.g. USB-RS485 converter or Bluetooth with OptoBTeX interface) or network connection. It requires computer with Microsoft Windows Vista (or higher) and Microsoft NET.Framework 4.5.2 (or higher).

Link ConFIT! app:

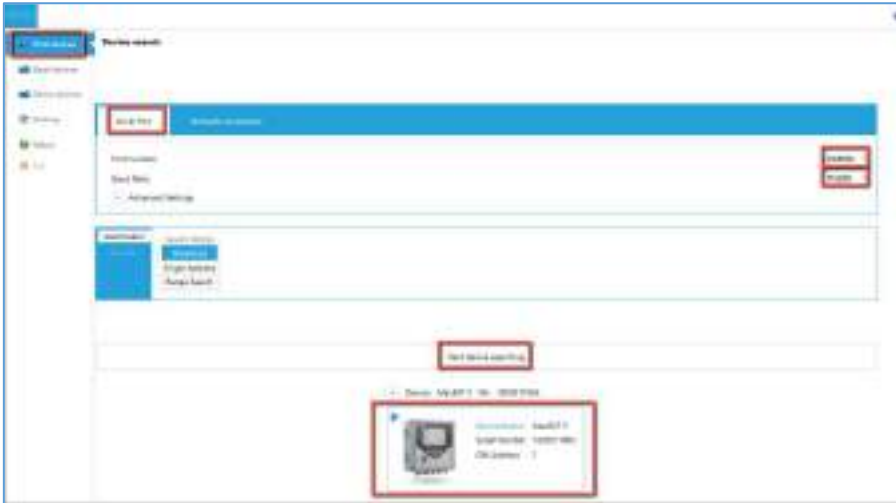

1. Connect device to computer via communication interface.
2. Start ConFIT! and go to 'Find devices' menu.
3. Choose 'Serial Port' communication channel.
4. Set COM port number assigned to communication interface.
5. Set Baud Rate of communication the same as set in device.
6. Start searching of device.
7. When device is found, click on it to connect.

8. Application automatically readouts device configuration and opens Profile view.

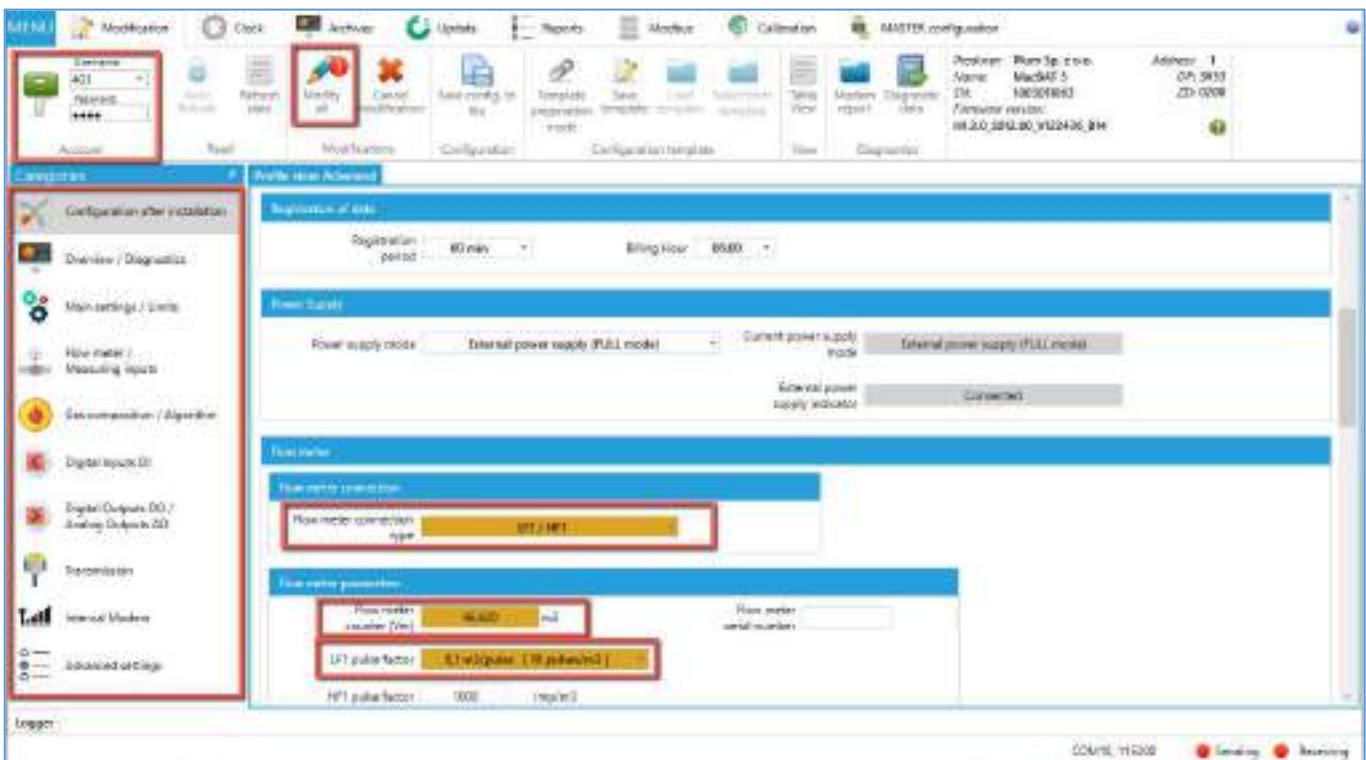

9. Set or choose authentication parameters (user name and password) in Account section, which allows device configuration. Application uses **401** account (Administrator) and **4096** password by default, to authorize modification of configuration.
10. Enter the new values for the configuration parameters in the individual setting Categories (left-hand menu of the profile view).
11. Confirm modification by clicking on 'Modify all' button. 13. If clicking 'Modify all' button doesn't cause any change, it means that authentication parameters (user name or password) was wrong.

TECHNICAL SUPPORT

Technical Support Department
Phone no.: +48 85 749 71 63
e-mail: support@plummac.com

Plum Sp. z o.o.
Ul. Wspólna 19, Ignatki
16-001 Kleosin
Poland
National Waste Database no.: 000009381